

THE PROPERTY OF THE DRAWING IS ESTABLISHED BY LAW. IT IS FORBIDDEN TO PRODUCE OR SHOW IT TO THIRD PART. WITHOUT A WRITTEN AGREEMENT.

Item	Name	Q.ty
1	CA.08.09.019	1
2	CA.08.28.013	1

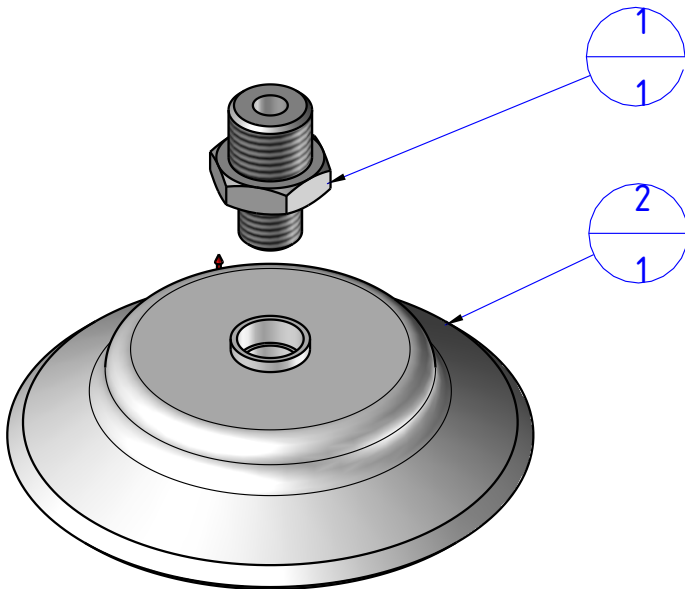
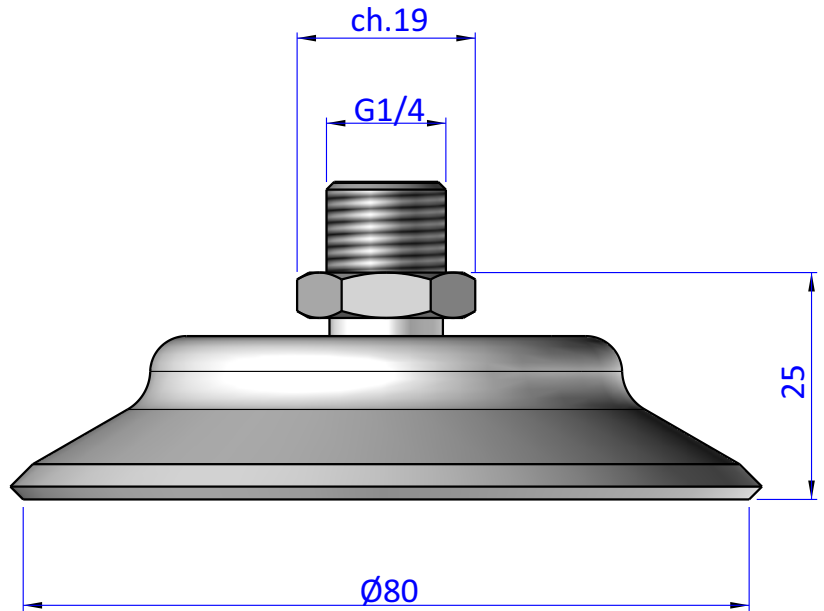

DESIGNED FROM		REVIEW
FPS Automation		A
DATE	WEIGHT	
07/01/2021	0,059kg	
CODE		
KIT.08.28.D80		

Format A4

UNI 936-76

GENERAL TOLERANCE

UNI - ISO 2768

CLASSE f

DESCRIPTION

KIT.08.28.D80